

# Data Sheet



Article number: 12525800050100

Description: KLEE-coil 525 800 050.100  
M5 Hardened, zinc-pl. & chr. yellow

## Measures

---

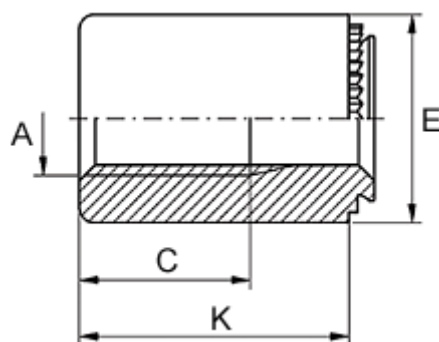

Female thread A	= M5
Height K	= 25
Min distance to edge	= 4.0
Outer diameter E	= 9
Plate thickness	= 0.8 to 1.0
Recommended bore diameter +0.05	= 6.00
Thread length	= 8.0